

Interface Connectors for Factory Automation Network

HR31 Series

Complies with Device Net requirements

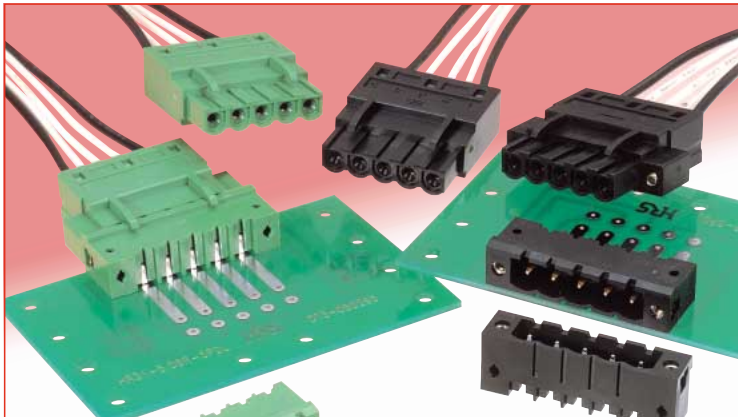

Comparison of plug heights (actual size)

●Hirose HR31

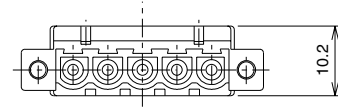

●Other manufacturer's product

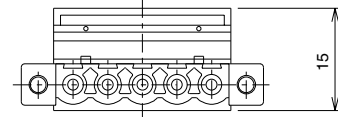

■ Features

1. Device-Net Compliant

Conforms to requirements of Factory Automation Network Device-Net standards.
 Hirose products are distinct from products of made others, as described below.

Feature	Made by others	Hirose HR31
Reduced number of termination operations	Crimped to commercially available cap connectors, inserted into housing and fastened by screw.	Crimped and connected to terminal then fastened simply by inserting into housing.
High density mounting	Plug height : 15 mm	Plug height is 10.2 mm, allowing use of less space when mounting several connectors
Prevention of connection errors	Contact positions not identified.	Permanently identified contact positions
Number of required operations to secure receptacle assembly to the board	Connectors are attached by screws from the opposite side.	No need for screws, built-in locking pin secures connector to the board

2 Locking features

The connectors can be supplied with either of the following locking features:

- Screw lock, using attached screws.
- Snap lock, using built-in feature with a definite click-sensation.

3. Commercially available tools may be used

Use crimp tools conforming to JIS C 9711 standards.
 Terminated contacts can be removed using 1 mm dia. steel pin. and re-inserted.

4. Prevention of deformation of the contacts

When fully inserted, the plug contacts are fully protected by the walls of the insulator body eliminating a risk of accidental damage.

■ Applications

Power units and communications units of factory automation related devices

Total space occupied by mated assemblies

With screw lock

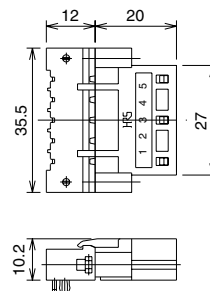

Without screw lock

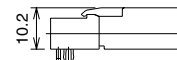
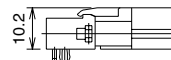
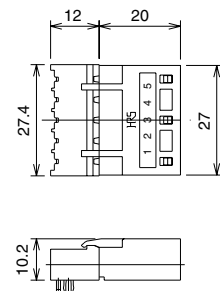

Product Specifications

Rating	Current rating	12A (2.5mm ² wire) 10A (1.5mm ² wire)	Operating temperature range	-40°C to +100°C
	Voltage rating	250V AC, 350V DC	Storage temperature range	-40°C to +85°C (Note 2)

Item	Specification	Conditions
1.Contact resistance	5 m ohms max.	1A DC
2.Insulation resistance	1000 M ohms min.	500 V DC
3.Withstanding voltage	No flashover or insulation breakdown	2000V AC/one minute
4.Impulse withstanding voltage	No flashover or insulation breakdown	Standard waveform of 4KV, positive/negative, 3 times each
5.Vibration	No electrical discontinuity of 10 μs or more	Frequency: 10 to 55 Hz, single amplitude of 0.75 mm, 5 min. in each of the 3 directions, 10 cycles each
6.Durability (insertion/ withdrawal)	Contact resistance: 10 m ohms max.	1000 cycles
7.Temperature cycle	Insulation resistance: 1000 M ohms min.	Temperature: -40°C → Room temperature to +100°C → Room temperature Time: 30 → 10 to 15 → 30 → 10 to 15 (Minutes) 5 cycles
8.Humidity	Insulation resistance: 10 M ohms min. (Humidity state) 100 M ohms min. (Dry state)	96 hours at temperature of 40°C and humidity of 90% to 95%

Materials

Part		Material	Finish	Remarks
Plug	Insulator	PBT	Color: Black or Green	UL94V-0
	Screw	Steel	Nickel plating	
Crimp contact	Socket contact	Contact area: phosphor bronze Termination area: copper	Contact area: gold plating Termination area: tin plating	
Receptacle	Insulator	PBT	Color: Black or Green	UL94V-0
	Male contact	Brass	Contact area: gold plating Termination are: gold plating	
	Nut	Steel	Nickel plating	
	Board retention pin	Phosphor bronze	Tin plating	

Ordering information

Connector

HR31 - 5.08 P A - 5 S C (01)

① ② ③ ④ ⑤ ⑥ ⑦ ⑧

① Series name	HR31	⑥ Contact type S: Female contact P: Male contact
② Contact pitch	5.08mm	
③ Connector type	P: Plug R: Receptacle	⑦ Terminal type C: Crimping DL: Right angle through hole type D: Straight through hole type
④ Screw lock type	Blank: With screw A: Without screw	
⑤ No. of contacts	5	⑧ Color, plating, board retention pin type

Crimp contact

HR31 - SC - 1 1 1 (01)

⑨ ⑩ ⑪ ⑫ ⑬ ⑭

⑨ Series name	HR31	⑬ Plating type 1: Gold plating
⑩ Contact type	SC: female contact	
⑪ Contact packaging type 1: loose contact		⑭ Suffix
⑫ Conductor cross area 1: 1.04 to 2.63mm ² 2: 0.25 to 1.65mm ²		

■ Plug (with screw lock)

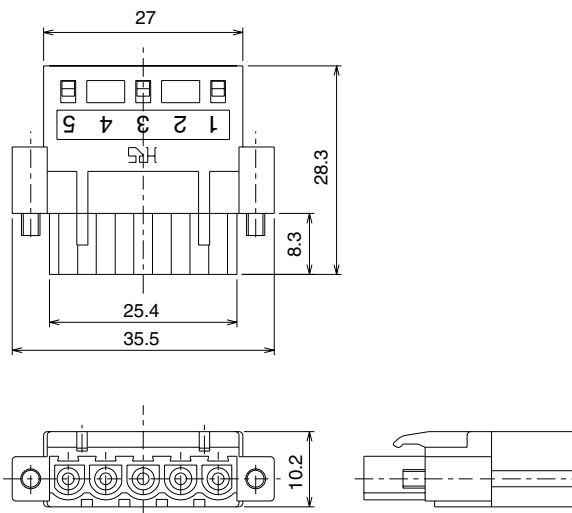
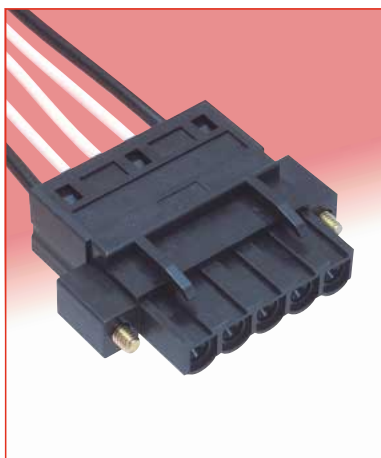

Part No.	CL No.	Weight	Color	RoHS
HR31-5.08P-5SC(71)	131-0002-2-71	8g	Black	YES
HR31-5.08P-5SC(72)	131-0002-2-72		Green	

■ Plug (without screw lock)

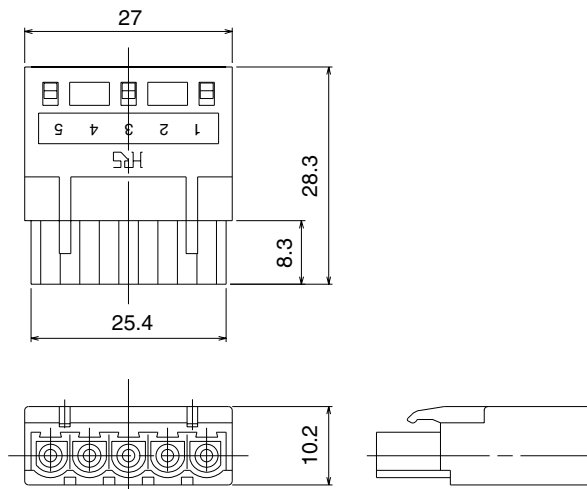

HR31-5.08PA-5SC

Part No.	CL No.	Weight	Color	RoHS
HR31-5.08PA-5SC	131-0009-1	6g	Black	YES
HR31-5.08PA-5SC(01)	131-0009-1-01		Green	

■ Crimp contact

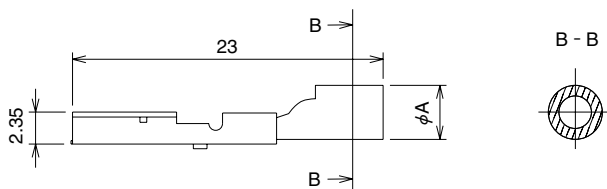

Part No.	CL No.	φA	Weight	Contact plating	Applicable conductor cross area (Note 2)	RoHS
HR31-SC-111(71)	131-0004-8-71	4	1g	Gold	1.04 to 2.63mm ²	YES
HR31-SC-121(71)	131-0005-0-71	3.3			0.2 to 1.65mm ²	

Note 1: Bag packaging (100 pieces/bag)

Note 2: For a multi-strand conductors

■ Receptacle (Right angle through hole type with screw lock)

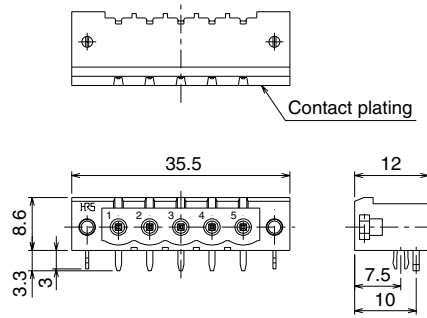

Part No.	CL No.	Weight	Color	Contact plating	Board retention pin	RoHS
HR31-5.08R-5PDL(72)	131-0001-0-72	4g	Black	Gold	With	YES
HR31-5.08R-5PDL(74)	131-0001-0-74				Without	
HR31-5.08R-5PDL(75)	131-0001-0-75		Green		With	
HR31-5.08R-5PDL(76)	131-0001-0-76				Without	

Receptacle (Right angle through hole type without screw lock)

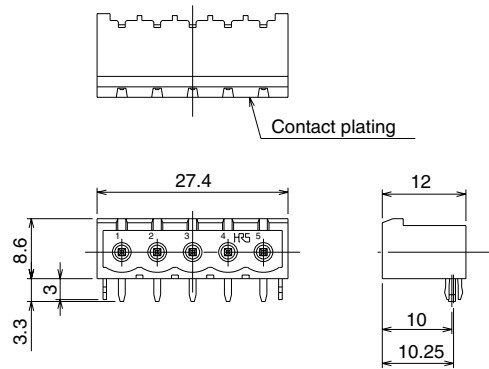

Part No.	CL No.	Weight	Color	Contact plating	Board retention pin	RoHS
HR31-5.08RA-5PDL(72)	131-0008-9-72	2g	Black	Gold	With	YES
HR31-5.08RA-5PDL(74)	131-0008-9-74				Without	
HR31-5.08RA-5PDL(75)	131-0008-9-75		Green		With	
HR31-5.08RA-5PDL(76)	131-0008-9-76				Without	

◆ PCB mounting pattern

● With screw lock

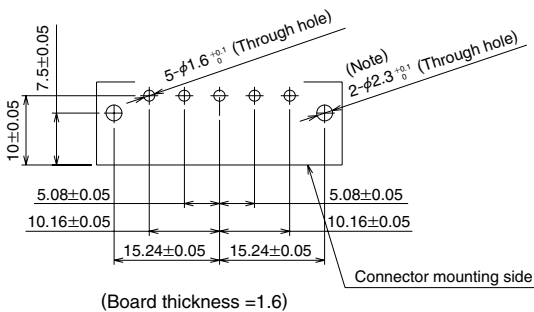

● Without screw lock

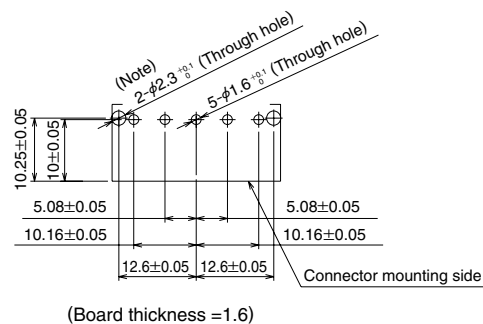

Note: Dia. 2.3 through hole is not required on the board when using connectors without the retention pin.

■ Receptacle (Straight through hole type with screw lock)

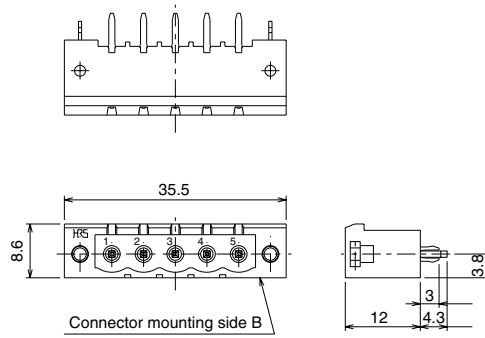

Part No.	CL No.	Weight	Color	Contact plating	Board retention pin	RoHS
HR31-5.08R-5PD(72)	131-0003-5-72	4g	Black	Gold	With	YES
HR31-5.08R-5PD(74)	131-0003-5-74				Without	
HR31-5.08R-5PD(75)	131-0003-5-75		Green		With	
HR31-5.08R-5PD(76)	131-0003-5-76				Without	

Receptacle (Straight through hole type without screw lock)

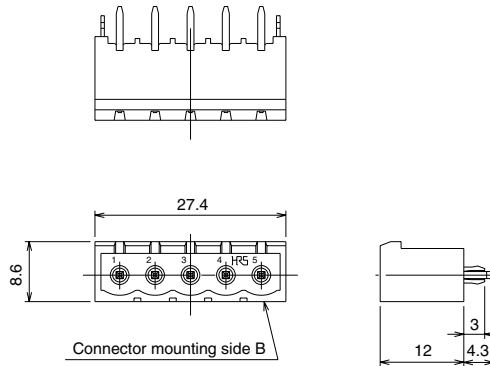
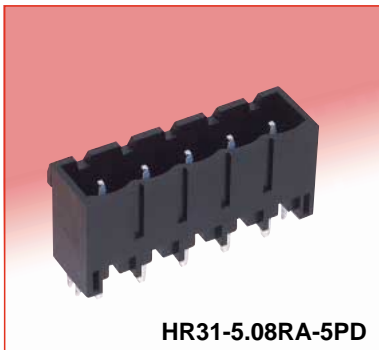

Part No.	CL No.	Weight	Color	Contact plating	Board retention pin	RoHS
HR31-5.08RA-5PD(72)	131-0016-7-72	2g	Black	Gold	With	YES
HR31-5.08RA-5PD(74)	131-0016-7-74				Without	
HR31-5.08RA-5PD(75)	131-0016-7-75		Green		With	
HR31-5.08RA-5PD(76)	131-0016-7-76				Without	

◆ PCB mounting pattern

● With screw lock

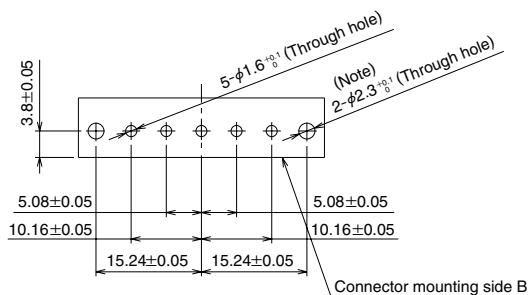

(Board thickness =1.6)

● Without screw lock

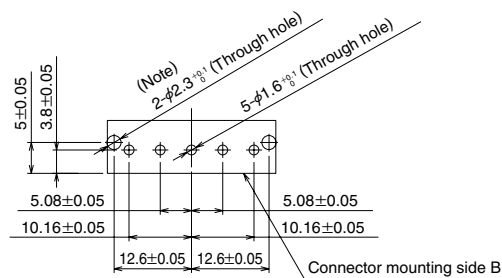

(Board thickness =1.6)

Note: Dia. 2.3 through hole is not required on the board when using connectors without the retention pin.

■ Tools

Type	Part No.	CL No.
Manual crimp tool	HR31-TC-01	150-0217-7
Contact removal pin	HR31-SC-TP	150-0215-1

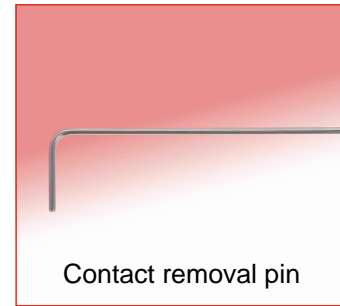

● Tools application procedures

1. Manual contact crimp tool

The tool will terminate all specified crimp contacts. Placement of correct contact in corresponding crimp position on the tool is critical. The positions are clearly indicated on the tool as (2) and (1.25). The exposed conductor strip length is 5mm.

Crimp position indicator	Applicable crimp contact
2	HR31-SC-113 or HR31-SC-111
1.25	HR31-SC-123 or HR31-SC-121

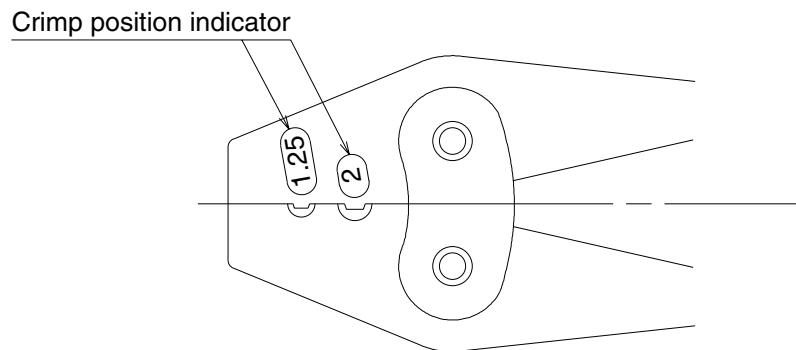

2. Contact removal pin

Contact removal pin provides easy method of contact removal from plug assembly.

- 1) Fully insert the long end of the contact removal pin into the opening in the insulator.
- 2) Move the pin forward, in the direction of the mating face.
This will cause the terminated contact to move in opposite direction.
- 3) Pull out the wire with the attached crimped contact.

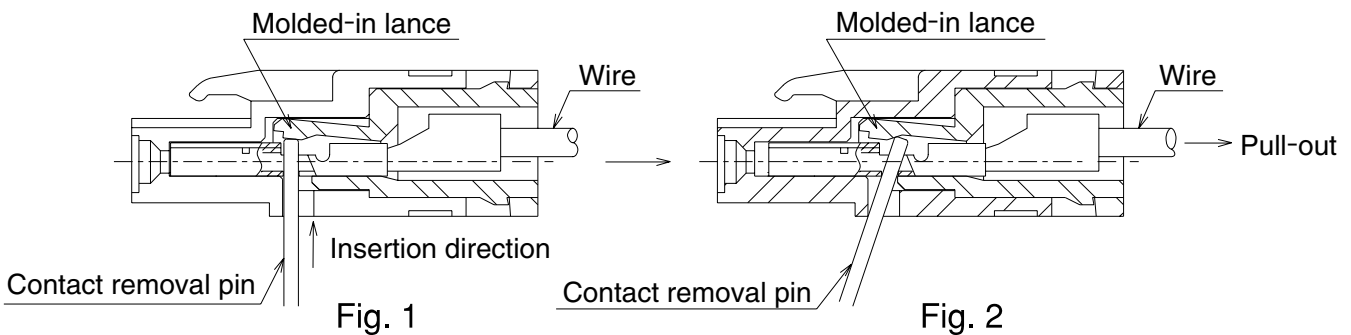

◆ Usage Precautions

1. To prevent damage, align receptacle with the panel and board in such a way that it is not subject to excess loads.

1.1 Recommended mounting panel dimensions (right angle through hole type)

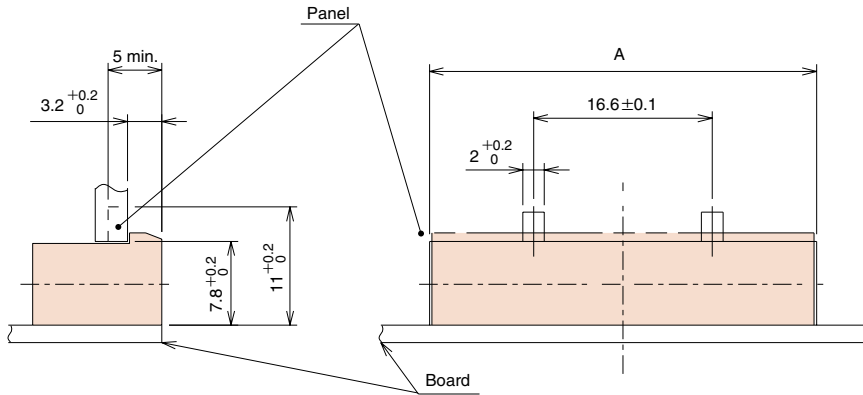

Part No.	A
HR31-5.08R-5PDL(**)	36 ^{+0.2} ₀
HR31-5.08RA-5PDL(**)	27.9 ^{+0.2} ₀

1.2 Recommended mounting panel dimensions (straight through hole type)

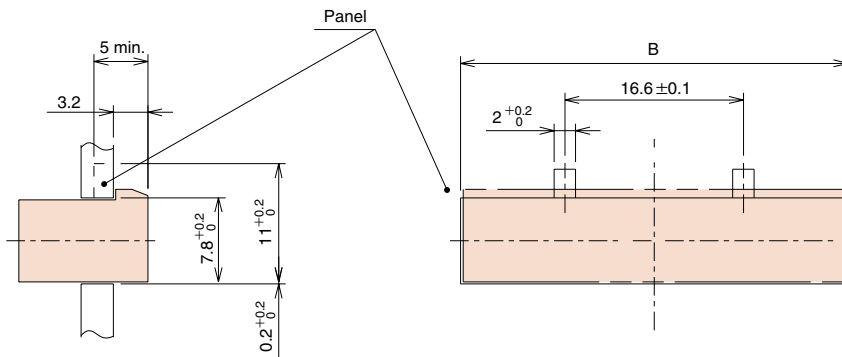

Part No.	B
HR31-5.08R-5PD(**)	36 ^{+0.2} ₀
HR31-5.08RA-5PD(**)	27.9 ^{+0.2} ₀

2. Insert the crimp contact into the plug in the direction shown below.

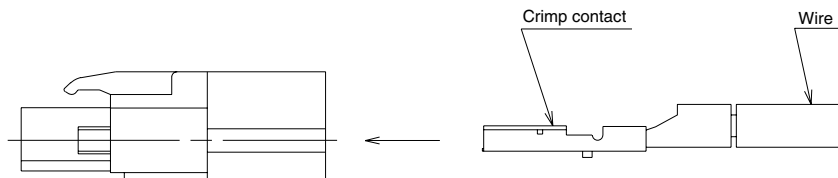

3. Use a number 0 cross drive bit to tighten the screw lock's screw.
4. Assure that the circuit's power is off when mating and un-mating connectors.